

Industrial Pressure Transmitters

Type F-20, F-21

with NEMA 4X Integral Junction Box

Applications

- Chemical industry
- Food industry
- Pharmaceutical industry
- Corrosive environments
- Mechanical engineering

Special Features

- Pressure ranges from 50 inWC to 15,000 psi
- 4-20mA and voltage signal outputs available
- Compact size and rugged construction
- All stainless steel design
- Integral electrical connection



Left: F-20 with standard NPT connection
Right: F-21 with flush diaphragm

Description

Compact, rugged design

The F-2X series of pressure transmitters are designed for installation in difficult, corrosive environments. The smooth exterior surfaces reduce areas where contaminants may collect and make it ideal for use in the food and pharmaceutical industries where washdown procedures for cleanliness are required.

The all stainless steel case meets NEMA 4X requirements for wash down and corrosion resistance, and ingress protection is available up to IP 68 per IEC 60 529.

Easily accessible electrical connection

The sophisticated design of this transmitter provides for fast, easy installation. The junction box cover unscrews for access to the internal spring clip terminal block.

Additional features

Transmitters with the 4-20mA output signal include an internal test circuit connection that permits the transmitter to be tested without disconnecting the primary 4-20 mA circuit. The model F-20 features an all-welded stainless steel measuring cell for improved media compatibility. There are no internal soft sealing materials that may react with the media or deteriorate over time.

The model F-21 features a flush diaphragm process connection. This flat sensing surface is specifically designed for the measurement of viscous fluids or media containing solids that may clog the NPT process connection.

Datasheet: F-20

Specifications
Model F-20 / F-21

Pressure range	50inWC	5psi	10psi	25psi	30psi	60psi	100psi	160psi	200psi
Maximum pressure*	15psi	29psi	58psi	145psi	145psi	240psi	500psi	1160psi	1160psi
Burst pressure**	29psi	35psi	69psi	170psi	170psi	290psi	600psi	1390psi	1390psi
Pressure range	300psi	500psi	1000psi	2000psi	3000psi	5000psi	8000psi	10000psi ¹	15000psi ¹
Maximum pressure*	1160psi	1160psi	1740psi	4600psi	7200psi	11,600psi	17,400psi	17,400psi	21,750psi
Burst pressure**	1390psi	5800psi	7970psi	14,500psi	17,400psi	24,650psi	34,800psi	34,800psi	43,500psi

{vacuum, gauge pressure, compound ranges, and absolute pressure references are available}

¹ Ranges only available with Type F-20

² For Model F-21 the burst pressure is limited to 21,000psi unless the pressure seal is accomplished by using the sealing ring underneath the hex.

*Pressure applied up to the maximum rating will cause no permanent change in specifications but may lead to zero and span shifts

**Exceeding the burst pressure may result in destruction of the transmitter and possible loss of media

Materials		
■ Wetted parts		(for other materials see WIKA diaphragm seal program)
➤ Models F-20		Stainless steel
➤ Models F-21		Stainless steel; O-ring: NBR {Viton or EPDM}
■ Case		Stainless steel
Internal transmission fluid ³⁾		Synthetic oil {Halocarbon oil for oxygen applications} ⁴⁾ {Listed by FDA for food applications}
		³⁾ Not available with F-20 on pressure ranges >300 psi
		⁴⁾ Media temperature for oxygen version: -30 ... +60 °C / -22 ... 140 °F Not available in vacuum and absolute pressure ranges or with Model F-21 flush diaphragm version > 500 psi
Power supply U _B	DC V	10 < U _B ≤ 30 (11 ... 30 with signal output 4 ... 20 mA, 14 ... 30 with signal output 0 ... 10 V)
Signal output and maximum load R _A		4 ... 20 mA, 2-wire R _A ≤ (U _B - 11 V) / 0.02 A with R _A in Ohm and U _B in Volt 0 ... 20 mA, 3-wire R _A ≤ (U _B - 3 V) / 0.02 A with R _A in Ohm and U _B in Volt {0 ... 5 V, 3-wire} R _A > 5 kOhm, {0 ... 10 V, 3-wire} R _A > 10 kOhm
Test circuit signal / max. load R _A		Only for instruments with 4 ... 20 mA signal output. R _A < 15 Ohm
Adjustability zero/span	%	± 10 using potentiometers inside the instrument
Response time (10 ... 90 %) ⁷⁾	ms	≤ 1
Isolation voltage	DC V	500
Accuracy ⁵⁾	% of span	≤ 0.25 {0.125} ⁶⁾ (BFSL)
	% of span	≤ 0.5 {0.25} ⁶⁾ (limit point calibration)
		⁵⁾ Including linearity, hysteresis and repeatability. Limit point calibration performed in vertical mounting position With pressure connection facing down.
		⁶⁾ For pressure ranges above 100 inWC
Non-repeatability	% of span	≤ 0.05
1-year stability	% of span	≤ 0.2 (at reference conditions)
Permissible temperature of		
■ Medium		-22 ... +212 °F {-40 ... +257 °F} ⁷⁾ -30 ... +100 °C {-40 ... +125 °C} ⁷⁾
■ Ambient		-4 ... +176 °F {-22 ... +221 °F} -20 ... +80 °C {-30 ... +105 °C}
■ Storage		-40 ... +212 °F -40 ... +100 °C
Compensated temperature range		32 ... +176 °F 0 ... +80 °C
		Also complies with EN 50178, Tab. 7, Type C, Class 4KH Operation, 1K4 Storage, 1K3 Transport
		⁷⁾ Response time F-20: ≤ 10 ms at medium temperatures below -30 °C (-22 °F) for pressure ranges up to 300 psi Response time F-21: ≤ 10 ms at medium temperatures below -30 °C (-22 °F)
Temperature coefficients (TC) within compensated temperature range:		
■ Mean TC of zero	% of span	≤ 0.2 / 10 K (<0.4 for pressure range ≤ 100 inWC)
■ Mean TC of range	% of span	≤ 0.2 / 10 K
CE- conformity		89/336/EWG interference emission and immunity see EN 61 326 interference emission limit class A and B 97/23/EG Pressure equipment directive (Module H)
Shock resistance	g	600 according to IEC 60068-2-27 (mechanical shock)
Vibration resistance	g	10 according to IEC 60068-2-6 (vibration under resonance)
Wiring protection		Protected against reverse polarity, overvoltage and short circuiting
Electrical connection		Internal spring clip terminals; wire cross section 2.5 mm ² max, internal ground Terminal for brass nickel-plated or {stainless steel} threaded connection {additional external ground terminal for stainless steel threaded conduit connection}
Weight	lb	Approx. 0.75

{ } Items in curved brackets are optional extras at additional cost.

Dimensions in inches (mm)

**1/2 NPT female conduit:
Ingress protection
NEMA 4X / IP 67**

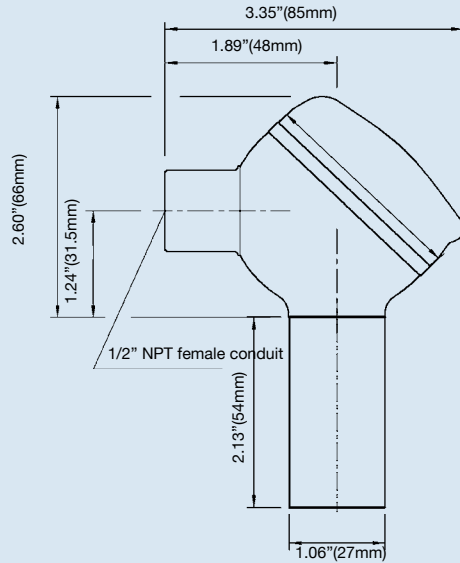

**Optional cable gland:
Ingress protection
NEMA 6 / IP 68
per IEC 60 529**

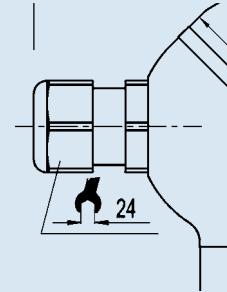

F-20 Pressure connections

1/2 NPT male
Order code: ND

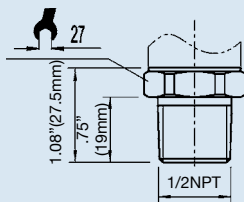

1/4 NPT male
Order code: NB

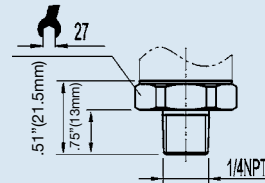

Other connections available

G 1/2 male
EN 837
Order code: GD

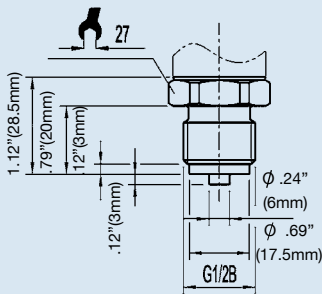

G1/4B male
Order code: GB

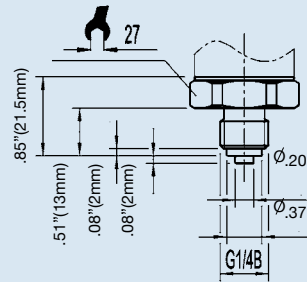

F-21 flush diaphragm pressure connections

G 1B
50 inWC to 25 psi
Order code: 85

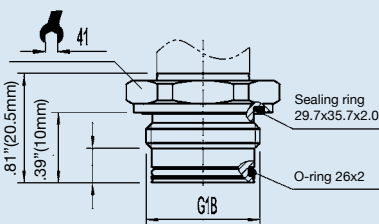

G 1/2B
30 psi to 8,000 psi
Order code: 86

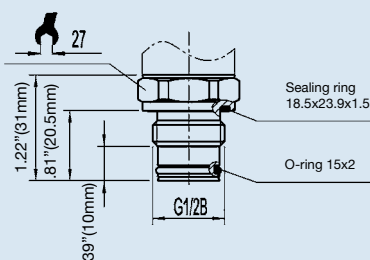

G 1
according to EHEDG **)
100 inWC to 250 psi
Order code: 83

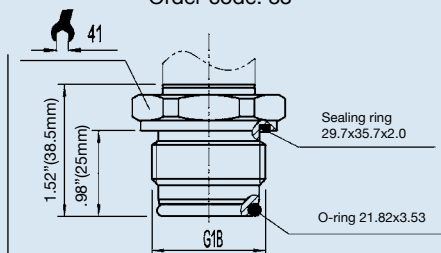

*) European Hygienic Equipment Design Group

Matching P-1 weld insert adapters for F-21 flush diaphragm transmitters

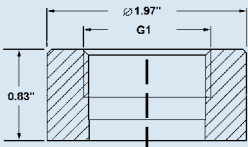

P-1 G1 weld insert adapter
Part # 1206974
for pressure ranges ≤ 25 psi

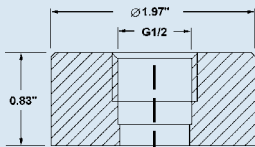

P-1 G1/2 weld insert adapter
Part # 1097008
for pressure ranges ≥ 30 psi

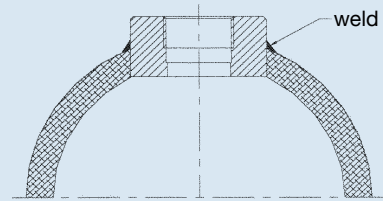

Cross section view of P-1 adapter installed in pipe.

Wiring

2-wire system

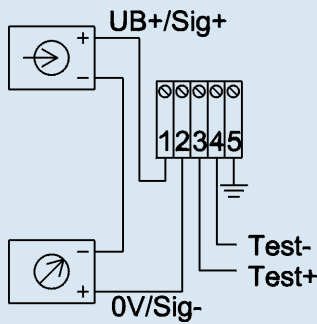

3-wire system

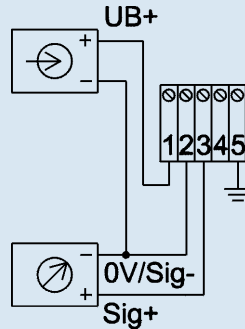

Legend:

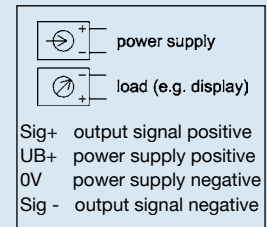

Calibration

Remove the junction box cover. Attach a meter and power supply to the electrical connector. For gauge ranges the zero potentiometer can be adjusted to produce a null output when no pressure is applied. Span adjustment requires the use of a reference pressure source. Compound and absolute ranges require a vacuum and pressure source. When calibration is complete, reinstall the junction box cover hand tight.

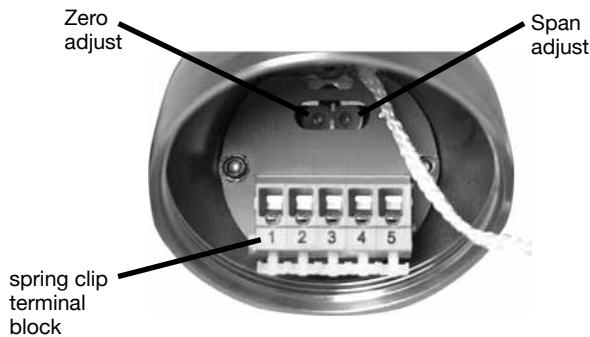

Related products:

IS-20-F integral junction box version for installation in hazardous environments



Models IS-20-F, IS-21-F
see datasheet IS-20

Type F-20 Industrial Pressure Transmitter With NEMA 4X Integral Junction Box

Standard Features

- **Signal Output:** 4-20 mA 2-wire
- **Supply Voltage:** 10-30 DC
- **Process Connection:** 1/2 NPT male
- **Electrical Connection:** Field case with 1/2" NPT female conduit



Gauge Ranges	
Description	
Range	Part #
0-50inWC	12127469
0-100inWC	12127477
0-5 psi	12127493
0-10 psi	12127507
0-15 psi	12127523
0-25 psi	12127531
0-30 psi	12127540
0-50 psi	12127558
0-60 psi	12127566
0-100 psi	12128873
0-160 psi	12127574
0-200 psi	12127582
0-300 psi	12127591
0-500 psi	12127639
0-1000 psi	12127671
0-2000 psi	12127681
0-3000 psi	12127699
0-5000 psi	12127701

Vacuum & Compound Ranges	
Description	
Range	Part #
30INHG VAC	12127400
30INHG/30 psi	12127418
30INHG/60 psi	12127426
30INHG/100 psi	12127434
30INHG/200 psi	12127451

NOTE: Ready-to-ship part numbers shown in **bold, blue** print.

Ready-to-ship part numbers are available from stock (subject to prior sale). Items without part numbers are available on special order.

Datasheet: F-20

F-20 Option List

Feature
Signal Output
4... 20 mA, 2-wire
0... 20 mA, 3-wire
0... 10 V, 3-wire
0... 5 V, 3-wire
On inquiry
Unit
psi
InWC
psi absolute
On inquiry
Pressure Range
-30 inHg ... 0
-30 inHg ... 30 psi
-30 inHg ... 60 psi
-30 inHg ... 100 psi
-30 inHg ... 160 psi
-30 inHg ... 200 psi
0 InWC ... 50 InWC
0 InWC ... 100 InWC
0 psi ... 5 psi
0 psi ... 10 psi
0 psi ... 15 psi
0 psi ... 25 psi
0 psi ... 30 psi
0 psi ... 50 psi
0 psi ... 60 psi
0 psi ... 100 psi
0 psi ... 160 psi
0 psi ... 200 psi
0 psi ... 250 psi
0 psi ... 300 psi
0 psi ... 400 psi
0 psi ... 500 psi
0 psi ... 600 psi
0 psi ... 750 psi
0 psi ... 1000 psi
0 psi ... 1500 psi
0 psi ... 2000 psi
0 psi ... 3000 psi
0 psi ... 5000 psi
0 psi ... 8000 psi
0 psi ... 10000 psi
0 psi ... 15000 psi

Feature
Pressure Range (continued)
0 psi ... 15 psi absolute
0 psi ... 25 psi absolute
0 psi ... 50 psi absolute
0 psi ... 100 psi absolute
0 psi ... 250 psi absolute
On inquiry
Process Connection
1/2"NPT
1/4"NPT
G1/2B
G1/4B
On inquiry
Special Design Features
Without
Suitable for food
Oxygen, oil and grease free
On inquiry
Accuracy
+/- 0.25% B.F.S.L.
+/- 0.125% B.F.S.L.
Electrical Connection
Field case, cable gland stainless steel conduit with spring clip terminal
Field case, cable gland brass nickel-plated with spring clip terminal
Field case, cable gland stainless steel with spring clip terminal
On inquiry
Temperature Range of Medium
-30 ... +100 °C (-22 ... +212 °F)
-40 ... +125 °C (-40 ... +257 °F)
Quality Certificates
Without
NIST Certificate of Calibration
Digital display
Without
Digital display
Additional order details
Without
Additional text

Type F-21 Flush Diaphragm Industrial Pressure Transmitter with NEMA 4X Integral Junction Box

Standard Features

- **Signal Output:** 4-20 mA 2-wire
- **Supply Voltage:** 10-30 DC
- **Process Connection:** G1/2B or G1B flush diaphragm depending upon pressure range
- **Electrical Connection:** Field case with 1/2" NPT female conduit



Gauge Ranges	
Description	
Range	Part #
0-50inWC ¹	12126331
0-5 psi ¹	12127728
0-10 psi ¹	12127736
0-100 psi	12127744

NOTES:

¹Pressure ranges from 50 inWC to 30 psi are supplied with G1B flush process connections; see Datasheet for details

NOTE: Ready-to-ship part numbers shown in **bold, blue** print.

Ready-to-ship part numbers are available from stock (subject to prior sale). Items without part numbers are available on special order.

F-21 Option List

Feature
Signal Output
4... 20 mA, 2-wire
0... 20 mA, 3-wire
0... 10 V, 3-wire
0... 5 V, 3-wire
On inquiry
Unit
psi
InWC
psi absolute
On inquiry
Pressure Range
-30 inHg ... 0
-30 inHg ... 30 psi
-30 inHg ... 60 psi
-30 inHg ... 100 psi
-30 inHg ... 160 psi
-30 inHg ... 200 psi
0 InWC ... 50 InWC
0 InWC ... 100 InWC
0 psi ... 5 psi
0 psi ... 10 psi
0 psi ... 15 psi
0 psi ... 25 psi
0 psi ... 30 psi
0 psi ... 50 psi
0 psi ... 60 psi
0 psi ... 100 psi
0 psi ... 160 psi
0 psi ... 200 psi
0 psi ... 250 psi
0 psi ... 300 psi
0 psi ... 400 psi
0 psi ... 750 psi
0 psi ... 1000 psi
0 psi ... 1500 psi
0 psi ... 2000 psi
0 psi ... 3000 psi
0 psi ... 5000 psi
0 psi ... 8000 psi

Feature
Pressure Range (continued)
0 psi ... 15 psi absolute
0 psi ... 25 psi absolute
0 psi ... 50 psi absolute
0 psi ... 100 psi absolute
0 psi ... 250 psi absolute
On inquiry
Process Connection
G 1 B, flush diaphragm with O-ring
G 1/2 B, flush diaphragm with O-ring
On inquiry
Material of Wetted Parts
Stainless steel, NBR O-Ring
Stainless steel, FPM/FKM O-Ring
On inquiry
Special Design Features
Without
Suitable for food
On inquiry
Accuracy
+/- 0.25% B.F.S.L.
+/- 0.125% B.F.S.L.
Electrical Connection
Field case, cable gland stainless steel conduit with spring clip terminal
Field case, cable gland brass nickel-plated with spring clip terminal
Field case, cable gland stainless steel with spring clip terminal
On inquiry
Temperature Range of Medium
-30 ... +100 °C (-22 ... +212 °F)
-40 ... +125 °C (-40 ... +257 °F)
-20 ... +150 °C (-4 ... +302 °F)
Quality Certificates
Without
NIST Certificate of Calibration
Digital display
Without
Digital display
Additional order details
Without
Additional text