

CHEMIQUIP POROUS METAL PRESSURE SNUBBERS

AIRCRAFT

Insure the reliable instrumentation needed for flight performance and aircraft safety by specifying Chemiquip Snubbers for hydraulic and pneumatic systems.

ALL AN AND MS TYPE FITTINGS ARE AVAILABLE AS SNUBBERS

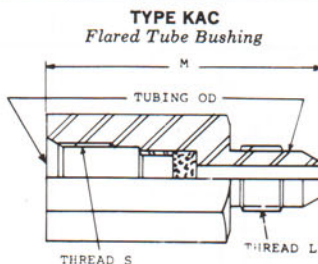
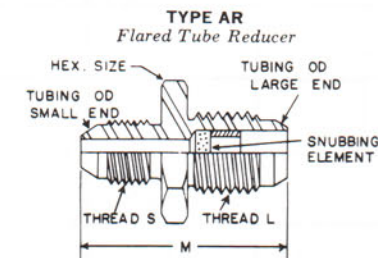
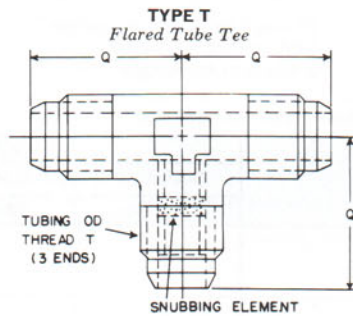
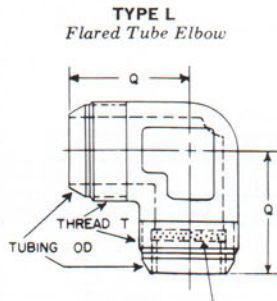
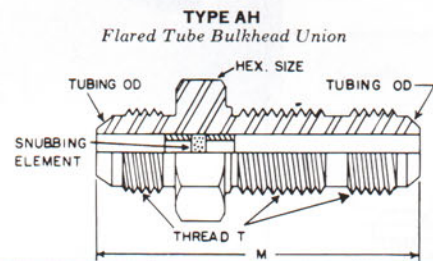
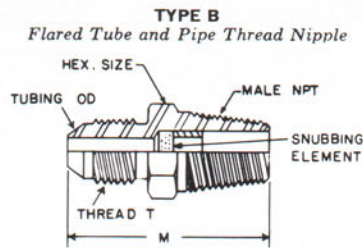
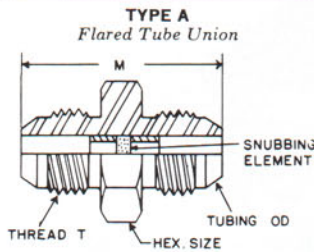

ORDERING INFORMATION:
When ordering, specify Part No. and Porosity designation. If required, CHEMIQUIP Engineers will aid in the selection of proper metal or porosity.

ENGINEERING DATA:

OPERATING CHARACTERISTICS

	Stainless St. Housing	Cad. Pltd. Carbon St. Hsg.	Bushing 302 St. St.	Porous Disc 316 St. St.
Burst Pressure	35,000 psi	30,000 psi	---	12,000 psi
Proof Pressure	23,200 psi	20,000 psi	---	6,500 psi
Working Pressure	11,600 psi	10,000 psi	5,500	5,500
Differential Press.	---	---	5,500	5,500 psi
Max. Oper. Temp.	1,300°F	1,300°F	1,300°F	1,300°F

AIRCRAFT SNUBBERS DIMENSIONS

CATALOG NUMBER	TUBING SIZE (Inches)	HEX (Inches)	DIMENSIONS M Q (Inches)	THREAD T	THREAD NPT
AC-1	1/4	13/16	1 1/4	3/16"-20	
AC-6	3/8	13/16	1 3/8	3/16"-18	
AC-8	1/2	1	1 3/8	3/4"-16	
12 BC-1	1/4	1/2	1 3/4	3/16"-20	1/8"
25 BC-1	1/4	9/16	1 3/8	3/16"-20	1/4"
25 BC-6	3/8	5/8	1 3/8	3/16"-18	1/4"
LC-1	1/4		57/64	3/16"-20	
LC-6	3/8		1 1/8	3/16"-18	
LC-8	1/2		1 1/4	3/4"-16	
TC-1,	1/4		55/64	3/16"-20	
TC-6	3/8		1 1/2	3/16"-18	
TC-8	1/2		1 3/2	3/4"-16	
AHC-1	1/4	13/16	2 3/4	3/16"-20	
AHC-6	3/8	13/16	2 3/2	3/16"-18	
AHC-8	1/2	1	2 3/4	3/4"-16	
ARC-1	1/8 x 1/4	13/16	1 1/4	THR. S	THR. L
1 ARC-6	1/4 x 3/8	13/16	1 13/2	3/16"-20	3/16"-18
1 ARC-10	1/4 x 1/2	1	1 13/2	3/16"-20	3/4"-16
1 KAC-1	1/4 x 1/4	13/16	1 45/64	3/16"-20	3/16"-20
6 KAC-1	3/8 x 1/4	13/16	1 23/64	3/16"-18	3/16"-20
6 KAC-6	3/8 x 3/8	3/4	1 3/8	3/16"-18	3/16"-18
8 KAC-1	1/2 x 1/4	1	1 37/64	3/4"-16	3/16"-20
8 KAC-6	1/2 x 3/8	1	1 35/64	3/4"-16	3/16"-18

STANDARD MATERIALS OF CONSTRUCTION

- Housing:**
- 303 Stainless Steel
 - 316 Stainless Steel
 - Cadmium Plated Carbon Steel
 - Aluminum
 - Monel
- Porous Disc:**
- 316 Stainless Steel
 - Monel