

Explosion Proof Pressure Transmitter Model E-10, E-11

Datasheet E-10



Applications

- Wellhead monitoring
- Refining, chemical, petrochemical
- Offshore platforms, pipelines
- Natural gas compressors

Special Features

- FM-approved Explosion proof for Class I Division 1 hazardous locations
- Available with 4 ... 20 mA, 2-wire or 1 ... 5 V, 3-wire low power output signals
- Engineered to withstand harsh environments
- NACE MR0175 compliant
- Retrofits many existing oil and gas applications

Description

The E-10 and E-11 explosion proof pressure transmitters are specifically designed to meet the durability and performance requirements of oil and gas pressure monitoring applications. These pressure transmitters feature an industry standard 4-20 mA 2-wire or 1-5V 3-wire low power signal output and NEMA 4X (IP67) ingress protection. They are extremely resistant to pressure spikes, vibration, and moisture intrusion. NACE MR-01-75 compliant wetted parts provides extra resistance against sulfide stress cracking when exposed to media containing sulphur. Both are available with a factory sealed epoxy flying lead assembly for easier installation.

The E-10 features an NPT process connection with an all-welded stainless steel measuring cell for media compatibility.

There are no internal soft sealing materials that may react with the media or deteriorate over time.



Left: E-10 NPT pressure transmitter with cable
Right: E-11 flush diaphragm pressure transmitter with optional flying leads

The E-11 features a flush diaphragm process connection. This flat sensing surface is specifically designed for the measurement of viscous fluids or media containing solids that may clog the NPT process connection.

The transmitters are engineered to meet Class I Division 1 Explosion proof protection for installation in hazardous environments. Each transmitter undergoes extensive quality control testing and calibration to achieve a linearity of $\leq 0.25\%$ full scale. In addition, each pressure transmitter is temperature compensated to assure accuracy and long-term stability even when exposed to severe ambient temperature variations.

Specifications

Model E-10 / E-11

Pressure range	5psi	10psi	15psi	25psi	30psi	60psi	100psi	200psi	300psi
Maximum pressure*	29psi	58psi	72psi	145psi	145psi	240psi	500psi	1160psi	1160psi
Burst pressure**	35psi	69psi	87psi	170psi	170psi	290psi	600psi	1390psi	1390psi
Pressure range	500psi	1000psi	1500psi	2000psi	3000psi	5000psi	8000psi ¹	10000psi ¹	15000psi ¹
Maximum pressure*	1160psi	1740psi	2900psi	4600psi	7200psi	11,600psi	17,400psi	17,400psi	21,750psi
Burst pressure**	5800psi	7970psi	11,600psi	14,500psi	17,400psi	24,650psi ²	34,800psi	34,800psi	43,500psi
{Vacuum, gauge pressure, compound ranges and absolute pressure ranges are available}									
Materials									
<ul style="list-style-type: none"> ■ Wetted parts <ul style="list-style-type: none"> > Model E-10 > Model E-11 									
Stainless steel (\geq 300 psi stainless steel and Elgiloy)									
Stainless steel {Hastelloy}									
O-ring: NBR {Viton}									
<ul style="list-style-type: none"> ■ Case 									
Stainless steel									
Internal transmission fluid									
Synthetic oil (only for pressure ranges up to 300 psi or flush diaphragm units)									
Power supply U_B	DC V		$10 < U_B < 30$ for 4 ... 20 mA, 2-wire $6 < U_B < 30$ for 1 ... 5 V, 3 wire low power version						
Signal output and maximum load R_A			$4 \dots 20$ mA, 2-wire $R_A \leq (U_B - 10 \text{ V}) / 0.02 \text{ A}$ with R_A in Ohm and U_B in Volt $1 \dots 5$ V, 3-wire $R_A > 10 \text{ kOhm}$						
Response time (10 ... 90 %)	ms		≤ 1 (≤ 10 ms when media temperatures are below -22°F (-30°C) for pressure ranges up to 300 psi or with flush diaphragm)						
Accuracy ³⁾	% of span		≤ 0.25 (BFSL)						
	% of span		≤ 0.5 (limit point calibration)						
Hysteresis	% of span		≤ 0.1						
Non-repeatability	% of span		≤ 0.05						
1-year stability	% of span		≤ 0.2 (at reference conditions)						
Permissible temperature of									
<ul style="list-style-type: none"> ■ Medium ■ Ambient ■ Storage 									
-22 ... +212 °F {-40 ... +221 °F} -30 ... +100 °C {-40 ... +105 °C}									
-22 ... +212 °F {-40 ... +221 °F} -30 ... +100 °C {-40 ... +105 °C}									
-40 ... +221 °F {-58 ... +221 °F} -40 ... +105 °C {-50 ... +105 °C}									
Compensated temp. range			32 ... +176 °F 0 ... +80 °C						
Temperature coefficients in compensated temp range									
<ul style="list-style-type: none"> ■ Mean TC of zero ■ Mean TC of range 									
% of span $\leq 0.2 / 10 \text{ K}$ (< 0.4 for pressure range < 100 inWC)									
% of span $\leq 0.2 / 10 \text{ K}$									
EMI specifications									
89/336/EWG interference emission and immunity see EN 61 326									
Approval authority									
<ul style="list-style-type: none"> ■ Factory mutual (FM / CSA) Explosion proof for: Class I, Division 1, Groups A, B, C and D ■ Dust ignitionproof for: Class II / III, Division 1, Groups E, F and G 									
FM Standards according to class number 3600, 3615 and 3810									
HF-immunity	V/m		10						
Burst	KV		4						
Shock resistance	g		1000 according to IEC 60068-2-27 (mechanical shock)						
Vibration resistance	g		20 according to IEC 60068-2-6 (vibration under resonance)						
Wiring protection			Protected against reverse polarity, over voltage and short circuiting						
Ingress protection			NEMA 4X / IP 67						
Weight	lb		Approximately 0.4						

* Pressure applied up to the maximum rating will cause no permanent change in specifications but may lead to zero and span shifts

**Exceeding the burst pressure may result in destruction of the transmitter

1) Only Model E-10.

2) For Model E-11: the burst pressure is limited to 21,000 psi unless the pressure seal is accomplished by using the sealing ring underneath the hex.

3) Includes linearity, hysteresis and repeatability. Limit point calibration performed in vertical mounting position with pressure connection facing down.

{ } Items in curved brackets are options available at additional cost.

Dimensions in inches (mm)

1/2 male conduit with 6 foot (1.6 m) cable and free ends
NEMA 4X (IP 67)
Order code: 2X

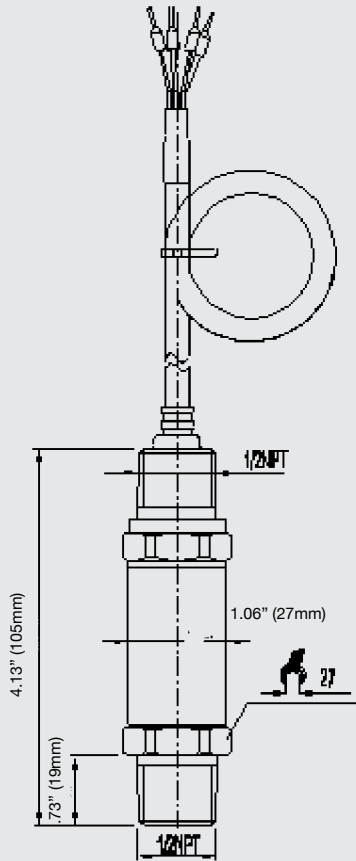

1/2 male conduit with 6 foot (1.6 m) flying leads NEMA 4X (IP 67)
Order code: 3X

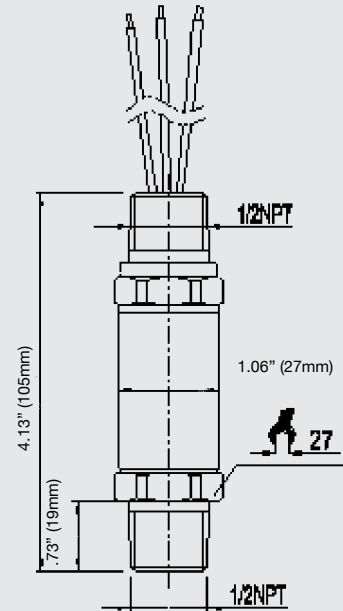

Pressure connections

1/4 NPT male
Order code: NB

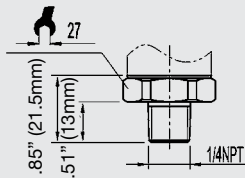

1/2 NPT male
Order code: ND

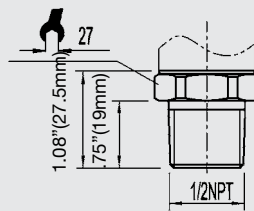

G 1/2 male
EN 837
Order code: GD

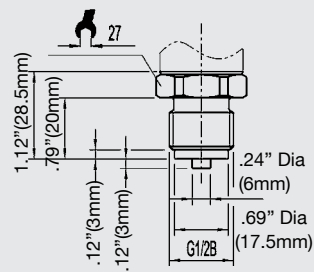

G 1/4 male
EN 837
Order code: GB

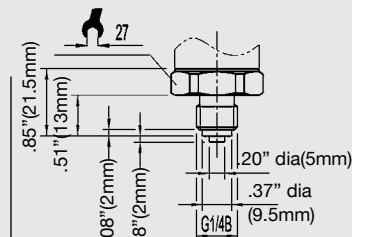

E-11 flush diaphragm pressure connections

E-11 G 1
50 INWC to 25 PSI
Order code: 85

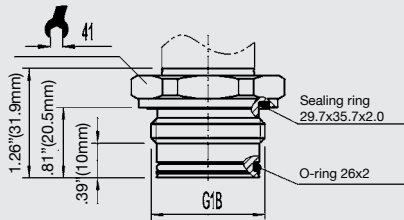

E-11 G 1/2
30 PSI to 8,000 PSI
Order code: 86

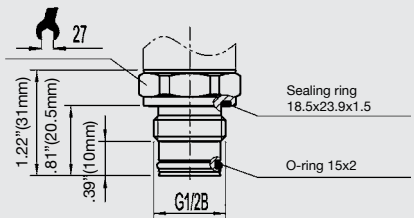

Matching P-1 weld insert adapters for E-11 flush diaphragm transmitters

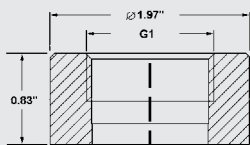

P-1 G1 weld insert adapter
Part # 1206974
for pressure ranges \leq 25 PSI

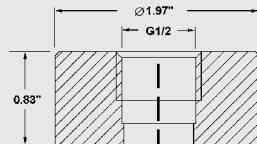

P-1 G1/2 weld insert adapter
Part # 1097008
for pressure ranges \geq 30 PSI

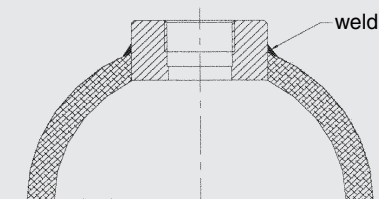

Cross section view of P-1 adapter installed in pipe.

Wiring

2-wire system

6 foot (1.82m)
cable or flying leads

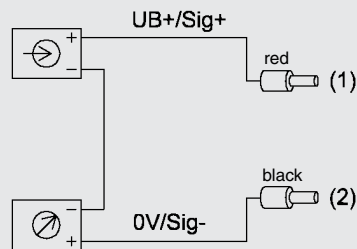

shield - ground

3-wire system

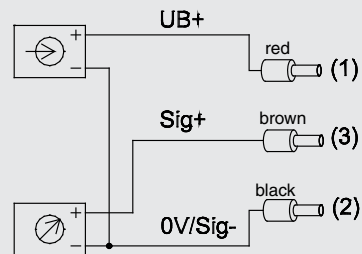

Green - ground

Legend:

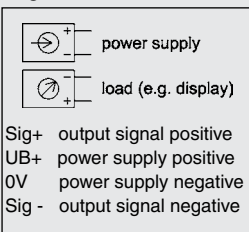

Specifications and dimensions given in this data sheet represent the state of engineering at the time of printing. Modifications may take place and materials specified may be replaced by others without prior notice.



WIKAI Instrument Corporation
1000 Wiegand Boulevard
Lawrenceville, GA 30043
1-888-WIKA-USA / 770-513-8200 (in GA)
Fax 770-338-5118
info@wika.com www.wika.com