

Explosion-Proof OEM Transmitters

Type E-10/E-11



Applications

Wellhead monitoring
Refining, chemical, petrochemical
Offshore platforms, pipelines
Natural gas compressors

Special Features

FM-approved Explosion proof for Class I
Division 1 hazardous locations
Available with 4 ... 20 mA, 2-wire or 1 ... 5 V,
3-wire low power output signals
Engineered to withstand harsh environments
NACE MR0175 compliant
Retrofits many existing oil and gas applications

Description

The E-10 and E-11 explosion proof pressure transmitters are specifically designed to meet the durability and performance requirements of oil and gas pressure monitoring applications. These pressure transmitters feature an industry standard 4-20 mA 2-wire or 1-5V 3-wire low power signal output and NEMA 4X (IP67) ingress protection. They are extremely resistant to pressure spikes, vibration, and moisture intrusion. NACE MR-01-75 compliant wetted parts provides extra resistance against sulfide stress cracking when exposed to media containing sulphur. Both are available with a factory sealed epoxy flying lead assembly for easier installation.

The E-10 features an NPT process connection with an all-welded stainless steel measuring cell for media compatibility.

There are no internal soft sealing materials that may react with the media or deteriorate over time.

Datasheet: E-10



Left: E-10 NPT pressure transmitter with cable
Right: E-11 flush diaphragm pressure transmitter with optional flying leads

The E-11 features a flush diaphragm process connection. This flat sensing surface is specifically designed for the measurement of viscous fluids or media containing solids that may clog the NPT process connection.

The transmitters are engineered to meet Class I Division 1 Explosion proof protection for installation in hazardous environments. Each transmitter undergoes extensive quality control testing and calibration to achieve a linearity of $\leq 0.25\%$ full scale. In addition, each pressure transmitter is temperature compensated to assure accuracy and long-term stability even when exposed to severe ambient temperature variations.

Specifications
Model E-10 / E-11

Pressure range	5psi	10psi	15psi	25psi	30psi	60psi	100psi	200psi	300psi
Maximum pressure*	29psi	58psi	72psi	145psi	145psi	240psi	500psi	1160psi	1160psi
Burst pressure**	35psi	69psi	87psi	170psi	170psi	290psi	600psi	1390psi	1390psi
Pressure range	500psi	1000psi	1500psi	2000psi	3000psi	5000psi	8000psi ¹	10000psi ¹	15000psi ¹
Maximum pressure*	1160psi	1740psi	2900psi	4600psi	7200psi	11,600psi	17,400psi	17,400psi	21,750psi
Burst pressure**	5800psi	7970psi	11,600psi	14,500psi	17,400psi	24,650psi ²	34,800psi	34,800psi	43,500psi
(Vacuum, gauge pressure, compound ranges and absolute pressure ranges are available)									
Materials									
■ Wetted parts									
> Model E-10	Stainless steel (\geq 300 psi stainless steel and Elgiloy)								
> Model E-11	Stainless steel {Hastelloy}								
	O-ring: NBR {Viton}								
■ Case	Stainless steel								
Internal transmission fluid	Synthetic oil (only for pressure ranges up to 300 psi or flush diaphragm units)								
Power supply U_B	DC V	10 < U_B < 30 for 4 ... 20 mA, 2-wire 6 < U_B < 30 for 1 ... 5 V, 3 wire low power version							
Signal output and maximum load R_A	4 ... 20 mA, 2-wire				$R_A \leq (U_B - 10 \text{ V}) / 0.02 \text{ A}$ with R_A in Ohm and U_B in Volt				
	1 ... 5 V, 3-wire				$R_A > 10 \text{ kOhm}$				
Response time (10 ... 90 %)	ms	≤ 1 ($\leq 10 \text{ ms}$ when media temperatures are below -22° F (-30° C) for pressure ranges up to 300 psi or with flush diaphragm)							
Accuracy ³⁾	% of span	≤ 0.25 (BFSL)							
	% of span	≤ 0.5 (limit point calibration)							
Hysteresis	% of span	≤ 0.1							
Non-repeatability	% of span	≤ 0.05							
1-year stability	% of span	≤ 0.2 (at reference conditions)							
Permissible temperature of									
■ Medium	-22 ... +212 °F		{-40 ... +221 °F}		-30 ... +100 °C		{-40 ... +105 °C}		
■ Ambient	-22 ... +212 °F		{-40 ... +221 °F}		-30 ... +100 °C		{-40 ... +105 °C}		
■ Storage	-40 ... +221 °F		{-58 ... +221 °F}		-40 ... +105 °C		{-50 ... +105 °C}		
Compensated temp. range	32 ... +176 °F				0 ... +80 °C				
Temperature coefficients in compensated temp range									
■ Mean TC of zero	% of span	$\leq 0.2 / 10 \text{ K}$ (< 0.4 for pressure range < 100 inWC)							
■ Mean TC of range	% of span	$\leq 0.2 / 10 \text{ K}$							
EMI specifications	89/336/EWG interference emission and immunity see EN 61 326								
Approval authority	■ Factory mutual (FM / CSA) Explosion proof for: Class I, Division 1, Groups A, B, C and D ■ Dust ignitionproof for: Class II / III, Division 1, Groups E, F and G FM Standards according to class number 3600, 3615 and 3810								
HF-immunity	V/m	10							
Burst	KV	4							
Shock resistance	g	1000 according to IEC 60068-2-27 (mechanical shock)							
Vibration resistance	g	20 according to IEC 60068-2-6 (vibration under resonance)							
Wiring protection	Protected against reverse polarity, over voltage and short circuiting								
Ingress protection	NEMA 4X / IP 67								
Weight	lb	Approximately 0.4							

* Pressure applied up to the maximum rating will cause no permanent change in specifications but may lead to zero and span shifts

**Exceeding the burst pressure may result in destruction of the transmitter

- 1) Only Model E-10.
 - 2) For Model E-11: the burst pressure is limited to 21,000 psi unless the pressure seal is accomplished by using the sealing ring underneath the hex.
 - 3) Includes linearity, hysteresis and repeatability. Limit point calibration performed in vertical mounting position with pressure connection facing down.
- { } Items in curved brackets are options available at additional cost.

Dimensions in inches (mm)

1/2 male conduit with 6 foot (1.6 m) cable and free ends
NEMA 4X (IP 67)
Order code: 2X

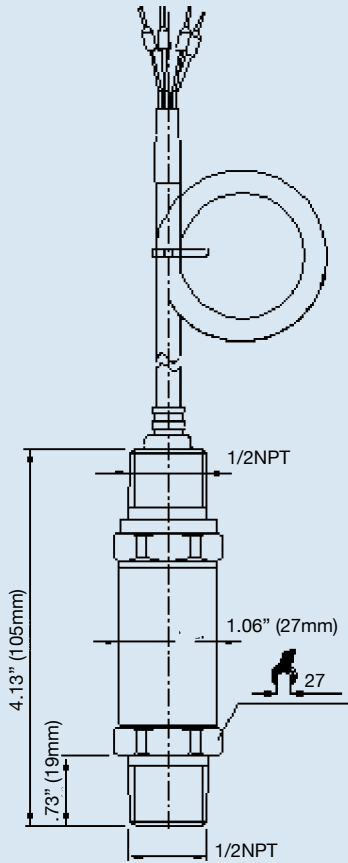

1/2 male conduit with 6 foot (1.6 m) flying leads NEMA 4X (IP 67)
Order code: 3X

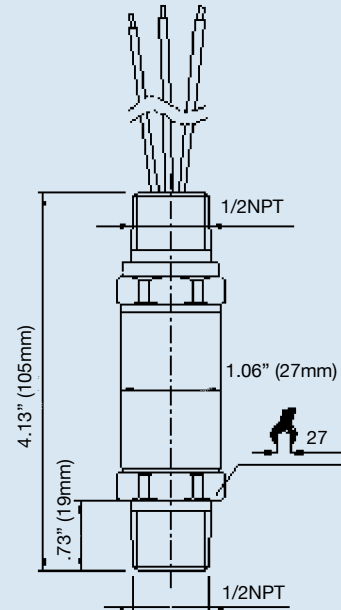

Pressure connections

1/4 NPT male
Order code: NB

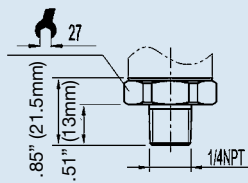

1/2 NPT male
Order code: ND

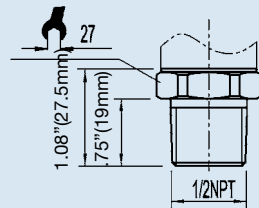

G 1/2 male
EN 837
Order code: GD

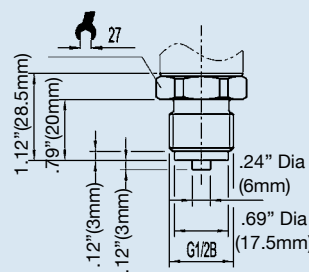

G 1/4 male
EN 837
Order code: GB

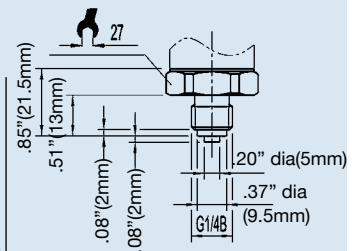

E-11 flush diaphragm pressure connections

E-11 G 1
50 inWC to 25 psi
Order code: 85

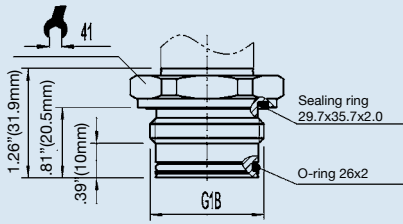

E-11 G 1/2
30 psi to 8,000 psi
Order code: 86

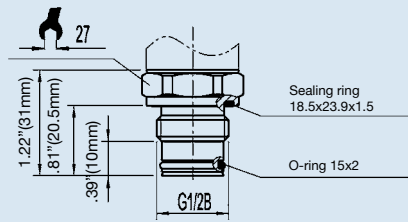

Matching P-1 weld insert adapters for E-11 flush diaphragm transmitters

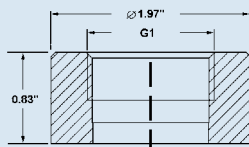

P-1 G1 weld insert adapter
Part # 1206974
for pressure ranges \leq 25 psi

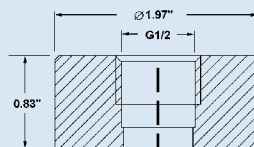

P-1 G1/2 weld insert adapter
Part # 1097008
for pressure ranges \geq 30 psi

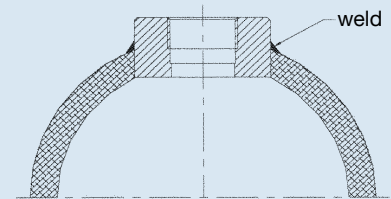

Cross section view of P-1 adapter installed in pipe.

Wiring

6 foot (1.82m)
cable or flying leads

2-wire system

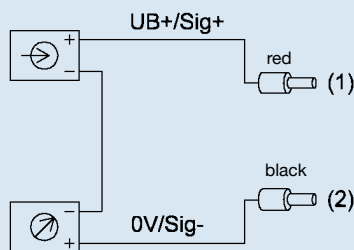

shield - ground

3-wire system

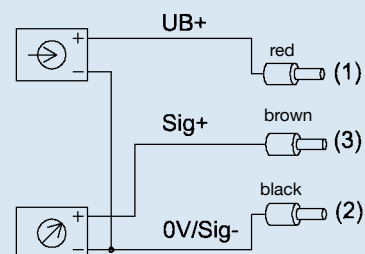

Green - ground

Legend:

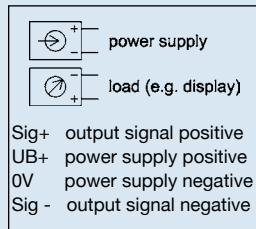

Type E-10 Explosion Proof Pressure Transmitter Vacuum to 15,000 psi

Standard Features

- Signal Output
- Supply Voltage:
- Process Connection:
- Electrical Connection:

Reference Charts Below



To use this table, first find the required process connection (1/4" or 1/2" NPT male), then the signal output (4-20 mA or 1-5 V), electrical connection (cable or flying lead), and the required pressure range.

Pressure Conn.	1/4" NPT male				1/2" NPT male			
	4-20 mA		1-5V 3-wire low power		4-20 mA		1-5V 3-wire low power	
Signal Output	1/2" NPT male conduit connection with:							
	6ft cable		6ft leads		6ft cable		6ft leads	
Electrical Conn.	1/2" NPT male conduit connection with:				1/2" NPT male conduit connection with:			
	6ft cable		6ft leads		6ft cable		6ft leads	
Compound Ranges								
30"-0 INHG/VAC					4371130			
30"-0-30 psi	4217172	50333330			4365016	4365131	4365255	
30"-0-100 psi	50116703	50300150			4365026	4365149	4365271	
Gauge Ranges								
15 psi		50989333		50034669	4365034	4365157	4365289	4365386
60 psi	4363082	50989341		50437178	4365042	4365166	4365297	
100 psi	4363090	4363189	4363341	50391020	4365050	4365174	4365301	4365395
200 psi	4364844	50139061	4242150	4368653	4369633	50033948		4254174
300 psi	4363103	4363197	4363359	4368661	4365068	4365182	4365319	
500 psi	4363111	4363200	4363367	4368679	4365076	4365190	4365327	4365408
1000 psi	4363129	4363218	4363376	4365337	4365085	4365204	4365336	4365418
1500 psi	4363137	4363226	4363384	4248337	4364169	4374130	4391256	4254166
2000 psi	4363146	4363236	4363392	4368687	4365093	4365212	4365344	4254158
3000 psi	4202506	4363244	4363406	4248329	4365106	4365220	4365352	4365425
5000 psi	4363155	4363252	4363414	4394034	4365115	4365238	4365360	4365433
8000 psi	4363163	4363260	50308696	50988906	50070568			
10,000 psi	4363171		4363422	50136623	4365123	4365246	4365378	4260957
15,000 psi			4216673				4216681	50131613

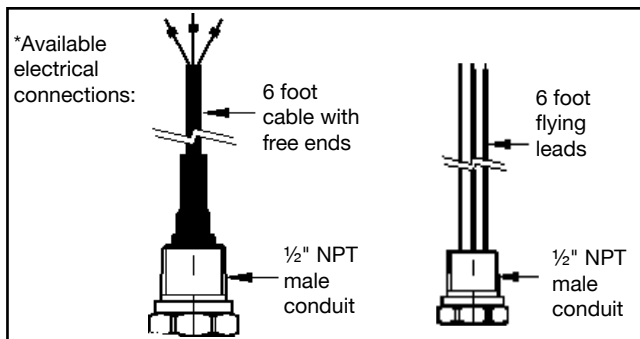

NOTE: Ready-to-ship part numbers shown in **bold, blue** print.

Ready-to-ship part numbers are available from stock (subject to prior sale). Items without part numbers are available on special order.

Datasheet: E-10

E-10 Option List

Feature
Signal Output
4... 20 mA, 2-wire
1... 5 V, 3-wire
Unit
psi
psi absolute
On inquiry
Pressure Range
-30 inHg ... 0
-30 inHg ... 30 psi
-30 inHg ... 60 psi
-30 inHg ... 100 psi
-30 inHg ... 200 psi
0 psi ... 5 psi
0 psi ... 10 psi
0 psi ... 15 psi
0 psi ... 30 psi
0 psi ... 50 psi
0 psi ... 60 psi
0 psi ... 100 psi
0 psi ... 160 psi
0 psi ... 200 psi
0 psi ... 250 psi
0 psi ... 300 psi
0 psi ... 500 psi
0 psi ... 750 psi
0 psi ... 1000 psi
0 psi ... 1500 psi
0 psi ... 2000 psi
0 psi ... 3000 psi
0 psi ... 5000 psi
0 psi ... 8000 psi
0 psi ... 10000 psi
0 psi ... 15000 psi
0 psi ... 15 psi absolute
0 psi ... 25 psi absolute
0 psi ... 50 psi absolute
0 psi ... 100 psi absolute
On inquiry

Feature
Process Connection
1/4" NPT
1/2" NPT
On inquiry
Special Design Features
Without
Low power
Electrical Connection
1/2" NPT male conduit with free ends (NEMA 4 / IP 67)
1/2" NPT male conduit with flying leads (NEMA 4 / IP 67)
Cable Length
6 feet
On inquiry
Approvals
Ex d per ATEX
Flameproof per FM and CSA
Quality Certificates
Without
NIST Certificate of Calibration
Additional Order Details
Without
Additional text

Type E-11 Explosion Proof Flush Diaphragm Pressure Transmitter Vacuum to 5000 psi

Standard Features

- Signal Output:
- Supply Voltage:
- Process Connection:
- Electrical Connection:

Reference
Charts
Below



Pressure Conn.	G1B or G1/2" B ¹			
Signal Output	4-20 mA		1-5V 3-wire low power	
Electrical Conn.	1/2" NPT male conduit connection with:			
	6 ft cable*	6 ft leads*	6 ft cable	6 ft leads*
Compound Ranges				
30"-0-30 psi ¹	4373087			
30"-0-100 psi				
Gauge Ranges				
0-15 psi ¹	4365441	4235694	4365530	4365581
0-100 psi	4365459	4365492	4365548	4365599
0-200 psi	4252414	50045954		
0-500 psi	50132423			4365611
0-1000 psi	4365467	4365506	4365556	4365629
0-1500 psi	50132440			4365637
0-2000 psi		50055712		4365646
0-3000 psi	4365476	4365514	4365565	4365654
0-5000 psi	4365484	4365522	4365573	4365662

¹ G1B for E-11 15 psi and 30INHG vacuum ranges, G1/2B for ranges > 30 psi

NOTE: Ready-to-ship part numbers shown in **bold, blue** print.

Ready-to-ship part numbers are available from stock (subject to prior sale). Items without part numbers are available on special order.

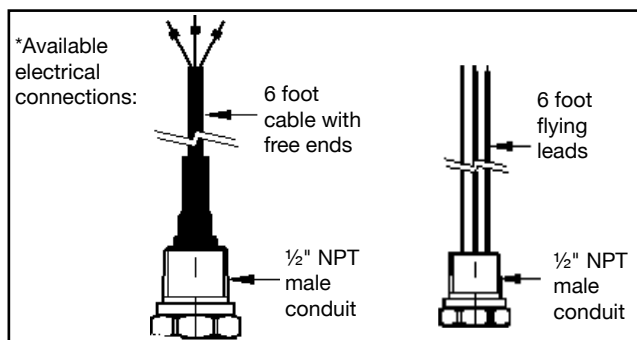

E-11 Option List

Feature
Signal Output
4... 20 mA, 2-wire
1... 5 V, 3-wire
Unit
psi
psi absolute
On inquiry
Pressure Range
-30 inHg ... 0
-30 inHg ... 30 psi
-30 inHg ... 60 psi
-30 inHg ... 100 psi
-30 inHg ... 200 psi
0 psi ... 5 psi
0 psi ... 10 psi
0 psi ... 15 psi
0 psi ... 25 psi
0 psi ... 30 psi
0 psi ... 50 psi
0 psi ... 60 psi
0 psi ... 100 psi
0 psi ... 160 psi
0 psi ... 200 psi
0 psi ... 250 psi
0 psi ... 300 psi
0 psi ... 500 psi
0 psi ... 750 psi
0 psi ... 1000 psi
0 psi ... 1500 psi
0 psi ... 2000 psi
0 psi ... 3000 psi
0 psi ... 15 psi absolute
0 psi ... 25 psi absolute
0 psi ... 50 psi absolute
0 psi ... 100 psi absolute
On inquiry

Feature
Process Connection
G 1 B flush diaphragm with O-ring
G 1/2 B flush diaphragm with O-ring
On inquiry
Material of Wetted Parts
Stainless steel, NBR O-ring
On inquiry
Special Design Features
Without
Low power
Electrical Connection
1/2" NPT male conduit with free ends (NEMA 4 / IP 67)
1/2" NPT male conduit with flying leads (NEMA 4 / IP 67)
Cable Length
6 feet
On inquiry
Approvals
Ex d per ATEX
Flameproof per FM and CSA
Quality Certificates
Without
NIST Certificate of Calibration
Additional Order Details
Without
Additional text