

# CHEMIQUIP POROUS METAL PRESSURE SNUBBERS

# AIRCRAFT

*Insure the reliable instrumentation needed for flight performance and aircraft safety by specifying Chemiquip Snubbers for hydraulic and pneumatic systems.*

**ALL AN AND MS TYPE FITTINGS ARE AVAILABLE AS SNUBBERS**

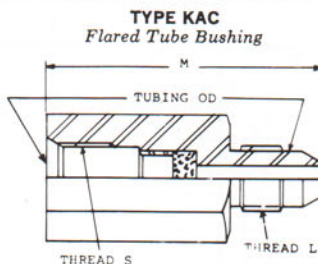
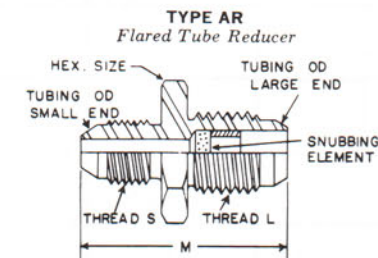
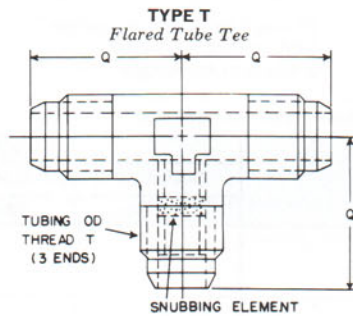
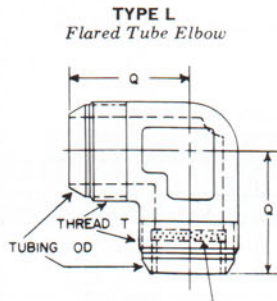
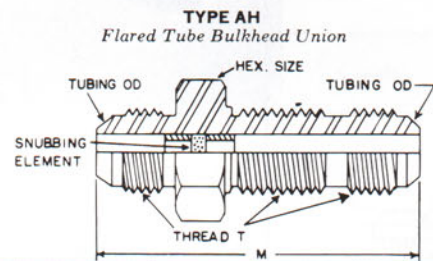
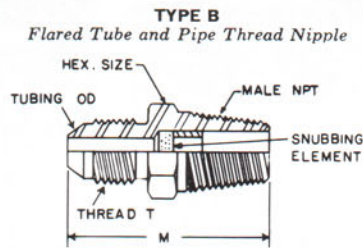
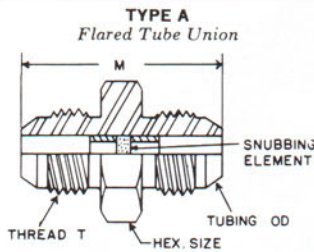

**ORDERING INFORMATION:**  
When ordering, specify Part No. and Porosity designation. If required, CHEMIQUIP Engineers will aid in the selection of proper metal or porosity.

## ENGINEERING DATA:

### OPERATING CHARACTERISTICS

	Stainless St. Housing	Cad. Pltd. Carbon St. Hsg.	Bushing 302 St. St.	Porous Disc 316 St. St.
Burst Pressure	35,000 psi	30,000 psi	---	12,000 psi
Proof Pressure	23,200 psi	20,000 psi	---	6,500 psi
Working Pressure	11,600 psi	10,000 psi	5,500	5,500
Differential Press.	---	---	5,500	5,500 psi
Max. Oper. Temp.	1,300°F	1,300°F	1,300°F	1,300°F

### AIRCRAFT SNUBBERS DIMENSIONS

CATALOG NUMBER	TUBING SIZE (Inches)	HEX (Inches)	DIMENSIONS M Q (Inches)	THREAD T	THREAD NPT
AC-1	1/4	13/16	1 1/4	3/16"-20	
AC-6	3/8	13/16	1 3/8	3/16"-18	
AC-8	1/2	1	1 3/8	3/4"-16	
12 BC-1	1/4	1/2	1 3/4	3/16"-20	1/8"
25 BC-1	1/4	9/16	1 3/8	3/16"-20	1/4"
25 BC-6	3/8	5/8	1 3/8	3/16"-18	1/4"
LC-1	1/4		57/64	3/16"-20	
LC-6	3/8		1 1/16	3/16"-18	
LC-8	1/2		1 1/4	3/4"-16	
TC-1	1/4		55/64	3/16"-20	
TC-6	3/8		1 1/32	3/16"-18	
TC-8	1/2		1 1/32	3/4"-16	
AHC-1	1/4	13/16	2 3/4	3/16"-20	
AHC-6	3/8	13/16	2 7/32	3/16"-18	
AHC-8	1/2	1	2 3/4	3/4"-16	
ARC-1	1/8 x 1/4	13/16	1 1/4	THR. S	THR. L
1 ARC-6	1/4 x 3/8	13/16	1 13/32	3/16"-20	3/16"-18
1 ARC-10	1/4 x 1/2	1	1 17/32	3/16"-20	3/4"-16
1 KAC-1	1/4 x 1/4	13/16	1 45/64	3/16"-20	3/16"-20
6 KAC-1	3/8 x 1/4	13/16	1 23/64	3/16"-18	3/16"-20
6 KAC-6	3/8 x 3/8	3/4	1 3/8	3/16"-18	3/16"-18
8 KAC-1	1/2 x 1/4	1	1 37/64	3/4"-16	3/16"-20
8 KAC-6	1/2 x 3/8	1	1 35/64	3/4"-16	3/16"-18

### STANDARD MATERIALS OF CONSTRUCTION

- Housing:**
- 303 Stainless Steel
  - 316 Stainless Steel
  - Cadmium Plated Carbon Steel
  - Aluminum
  - Monel
- Porous Disc:**
- 316 Stainless Steel
  - Monel